



ARIS | WHAT'S NEW?

USER GROUP NORDIC

Helge Hess

ARIS Product Management / Marketing



TRANSFORM.MANAGE.CONTROL

Manage Constant Change

CONTROL
HOW YOUR ORGANISATION
ACTUALLY PERFORMS

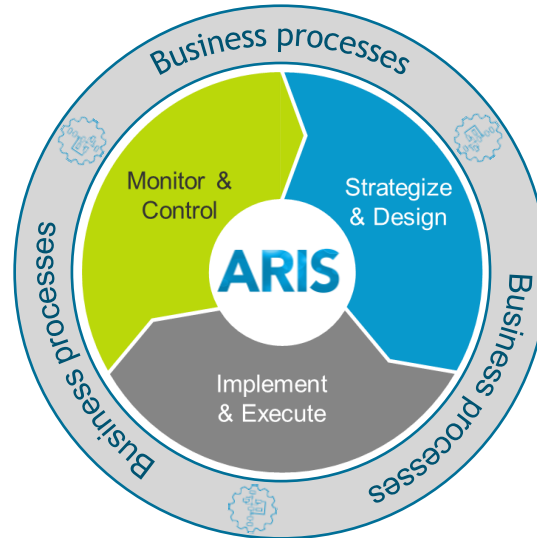
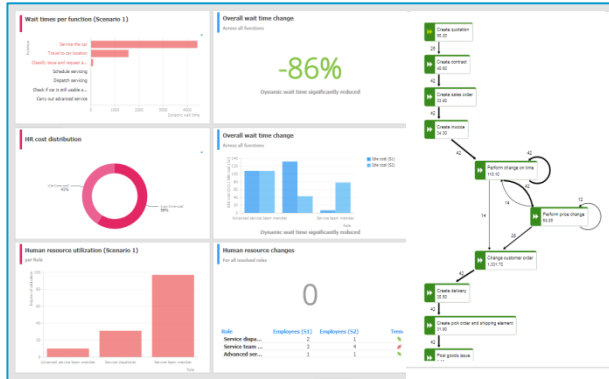

TRANSFORM
HOW TO
WIN IN THE MARKET

- Business Model & Strategy
- Processes & Decisions
- Customer Journeys
- Products & Services
- Organization & People
- Information & Data
- Systems & Internet of Things
- Risks & Controls

MANAGE
HOW TO
RUN YOUR BUSINESS

Enterprise Digital Twin



- Digital representation of organizational units, their assets and processes

Digital Twin



- Digital representation of physical objects and systems

Enterprise Digital Twin



- Digital representation of organizational units, their assets and processes



- **VISUALIZE** interdependencies
- **TRANSLATE** the strategy into initiatives and outcomes
- **CONNECT** with real-life data
- **SIMULATE** changes and **EVALUATE** the effects
- **IMPROVE** continuously

**TRANSFORMATION
OFFICE**

**LINES of
BUSINESS**

DEFINE YOUR "BUSINESS OPERATING MODEL"

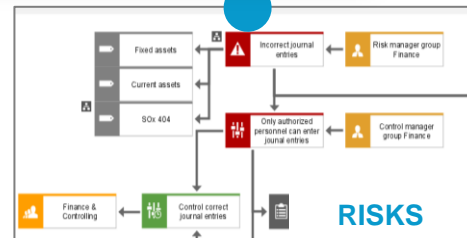
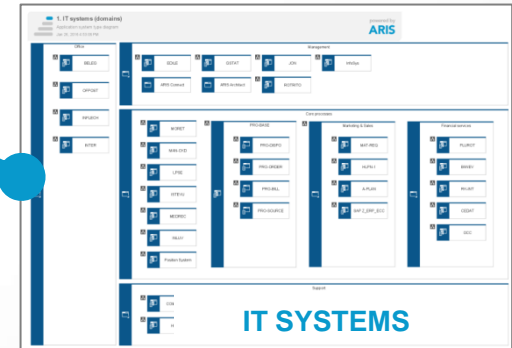
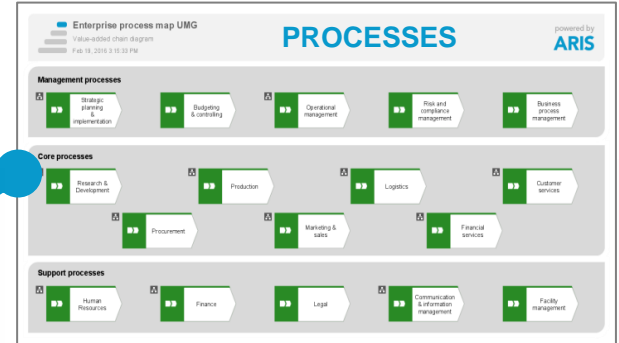
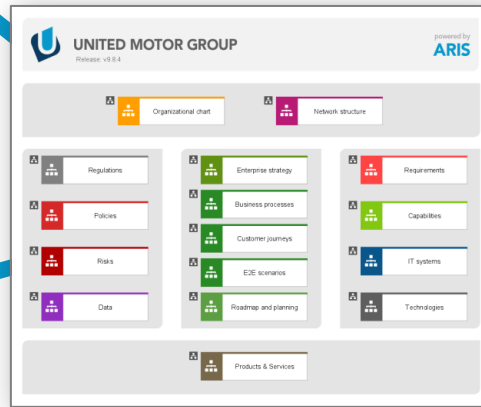
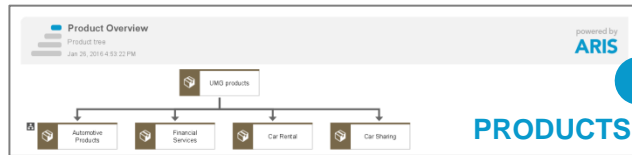
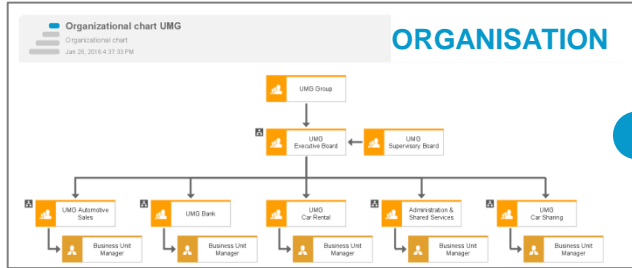

PROCESS MATURITY

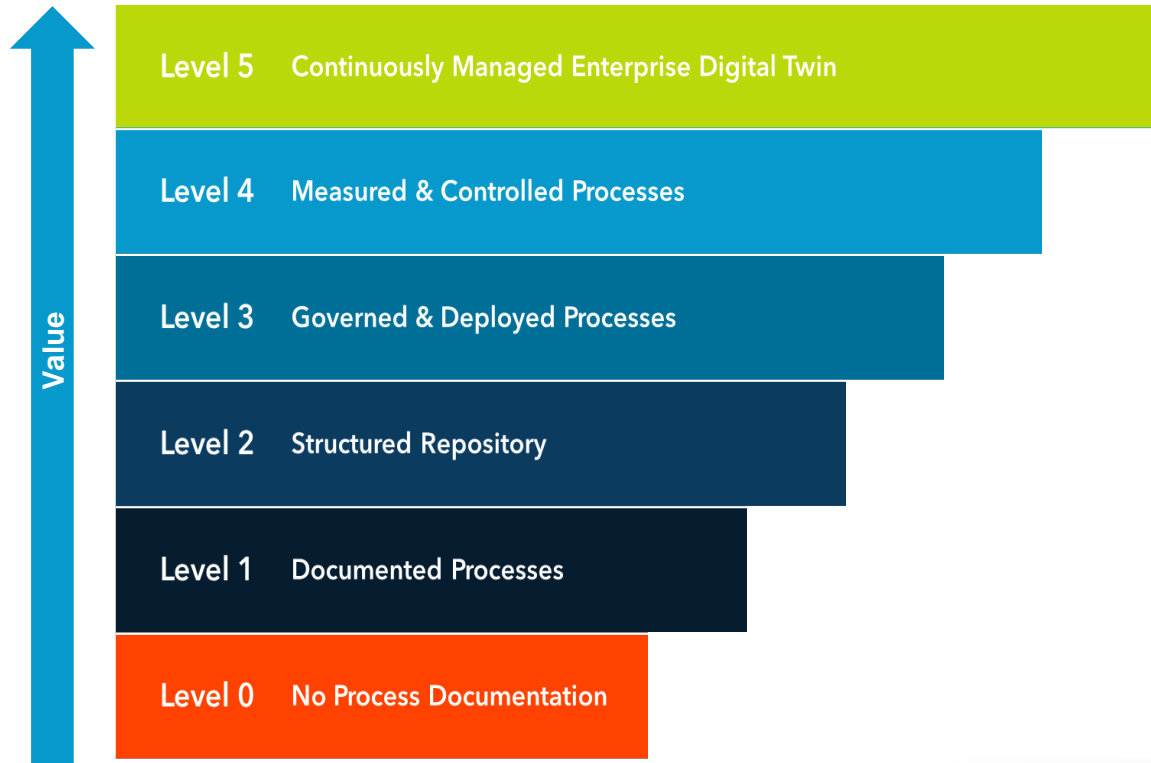

LARGE ENTERPRISE SCENARIOS



ENTERPRISE MANAGEMENT SYSTEMS

- **Guidance** – Distribute knowledge across the organization with role-specific access
- Simple and fast **onboarding** of new employees
- **Establish quality** in global business processes
- Ensure **compliance, certification & trust**
- Achieve **global process roll-out** in the context of (SAP) standardization
- Continuous **change management**

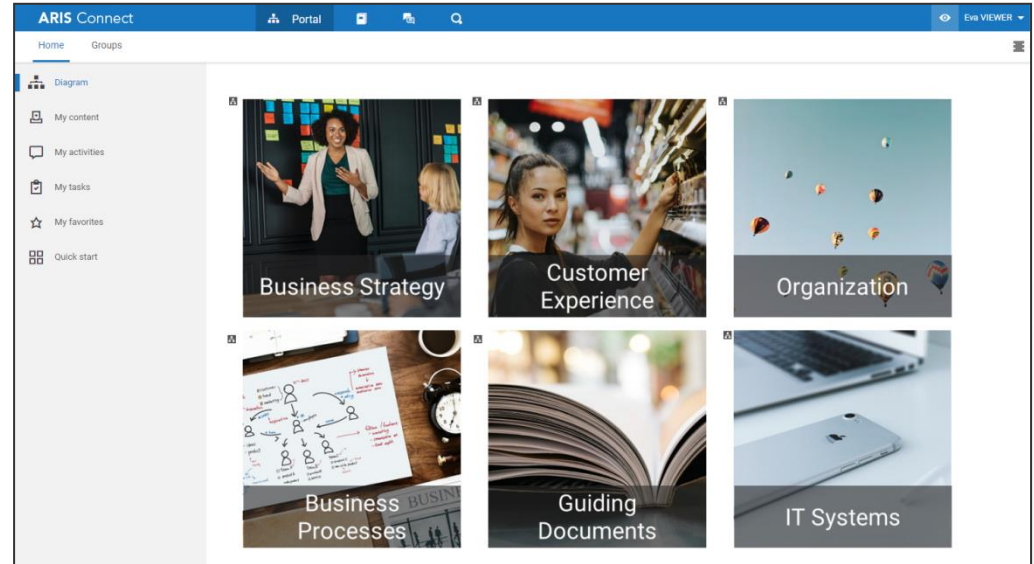

120.000

ARIS users at a Brazilian Bank

100.000

ARIS users at a UK-based retail company

90.000

ARIS users at Dutch-based tech company

PERFORMANCE

STARTUP, QUERIES & SPREADSHEETS

up to

30%

reduced startup time for
Connect Designer

15-85%

reduced time for executing
Queries

up to

90%

reduced time to open a
Spreadsheet model

Number of visits over time

Visitors Unique visitors

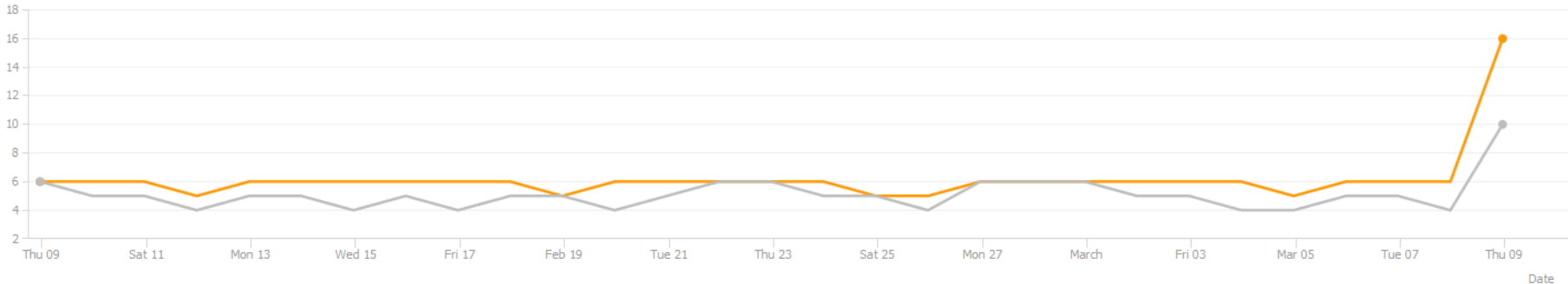

Most viewed item types (e.g., 'Process', 'Role')

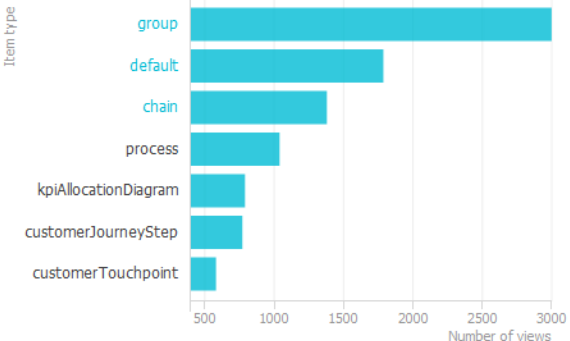

Most viewed items

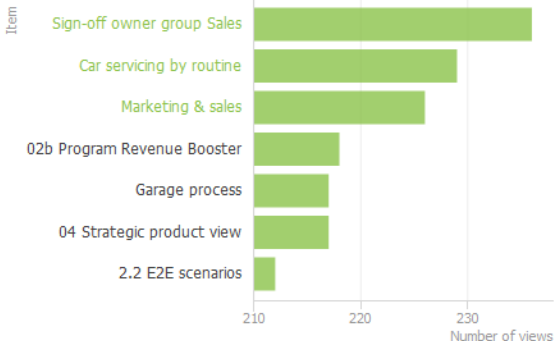

Most searched keywords

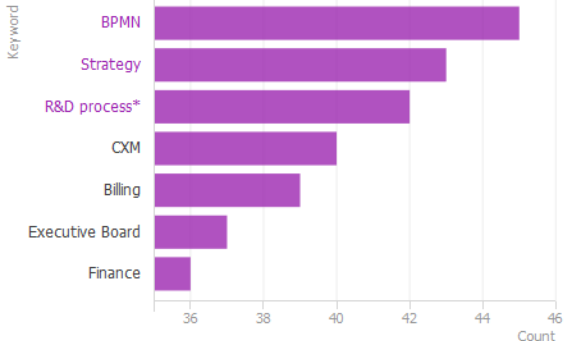

LARGE ENTERPRISE SCENARIOS

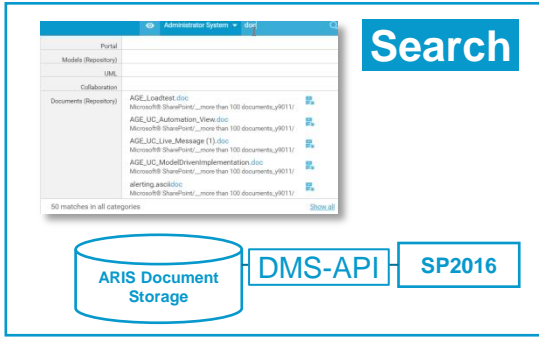

Integration with **MS SharePoint 2016**

Intelligent Document search (to find only approved versions of documents, ..)

Mirroring the display for **Right-to-left languages** (Arabic, Hebrew, Persian, and Urdu)

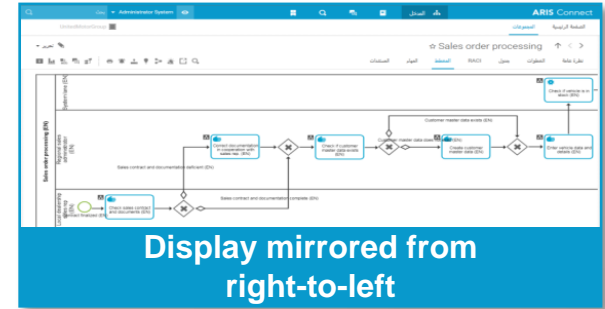
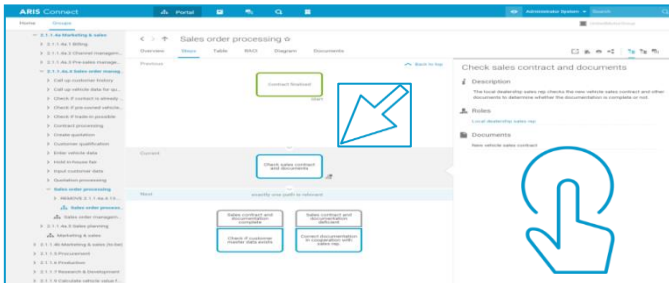

Accessibility through enhanced **keyboard controls**



STANDARDS and WEB-BASED MODELING



Processes



**Business Model &
Strategy**

**Processes &
Decisions**

**Customer
Journeys**

**Products &
Services**

**Organization &
People**

**Information &
Data**

**Systems &
Internet of Things**

**Risks &
Controls**

THE UNDERSTANDING OF BUSINESS MODELS

Design and Analysis of Business Models

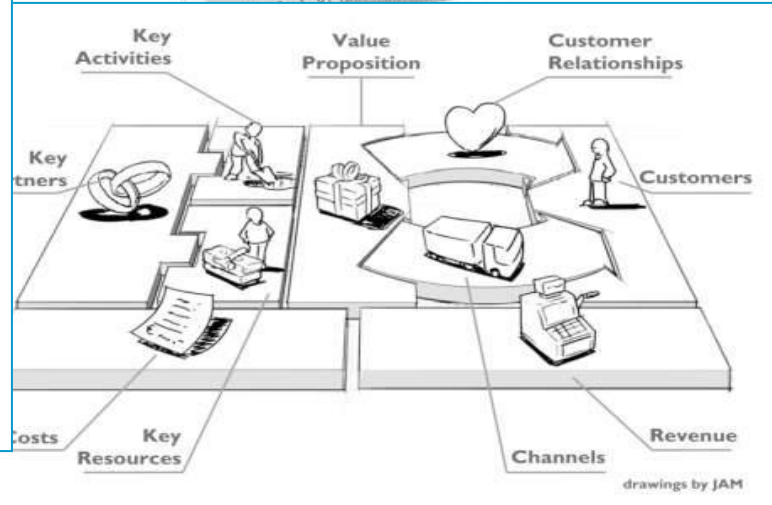
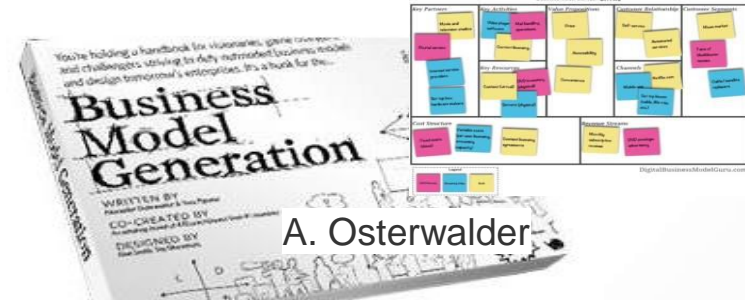
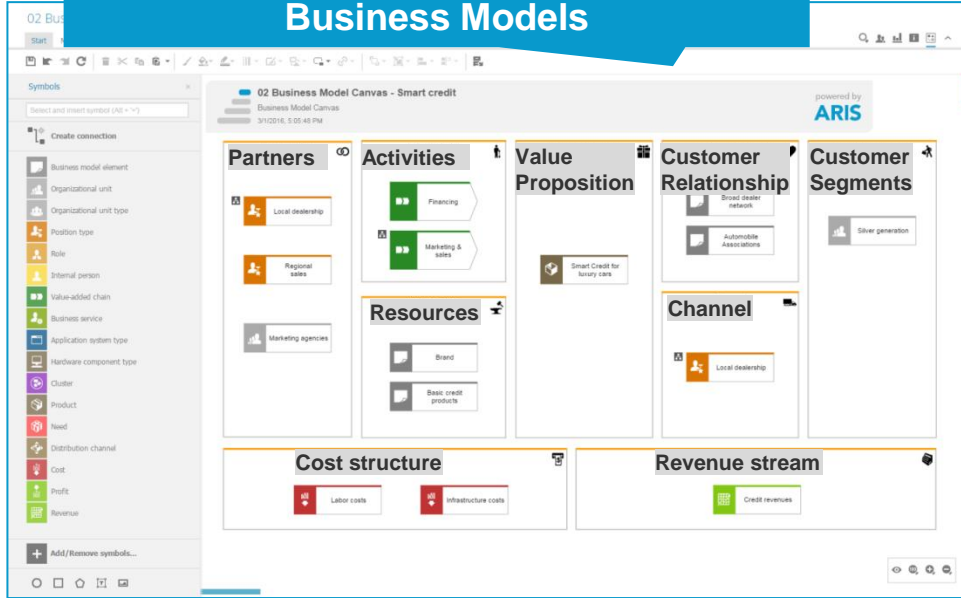

BUSINESS MODEL DEFINITION

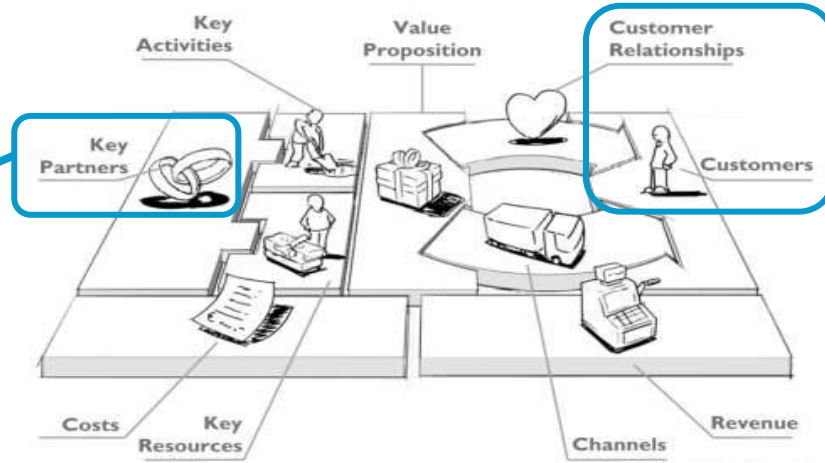

Business Model Canvas

Define your Digital Business Model

Business Ecosystems

Identify digitalization opportunities by visualizing the ecosystem of your organization

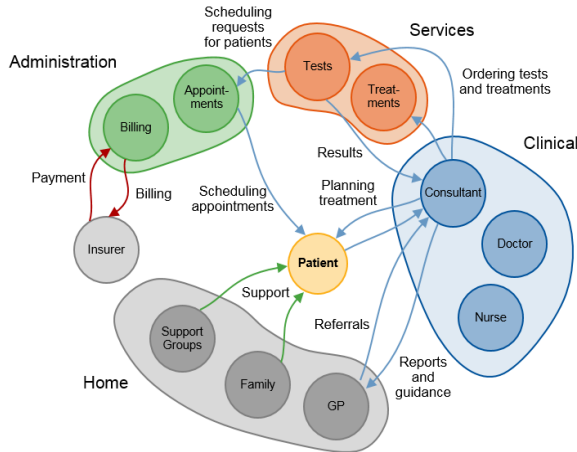

Customer Journeys

Discover touchpoints and moments of truths along the customer journeys

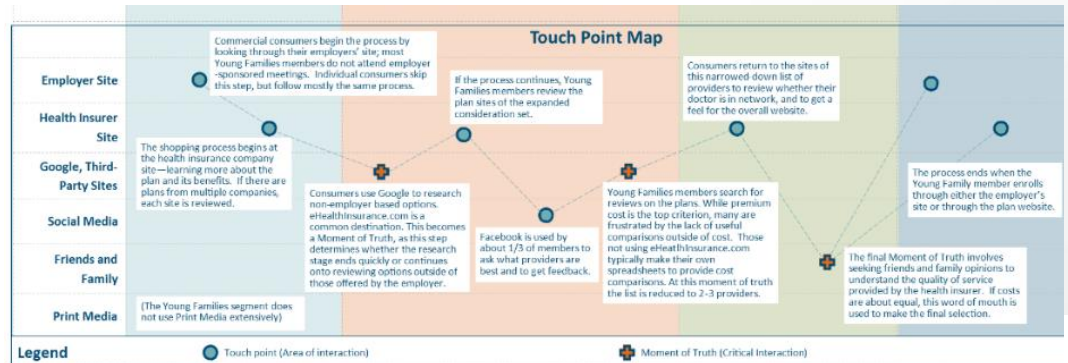

BUSINESS MODEL DEFINITION

Business Ecosystems

Identify digitalization opportunities by visualizing the ecosystem of your organization

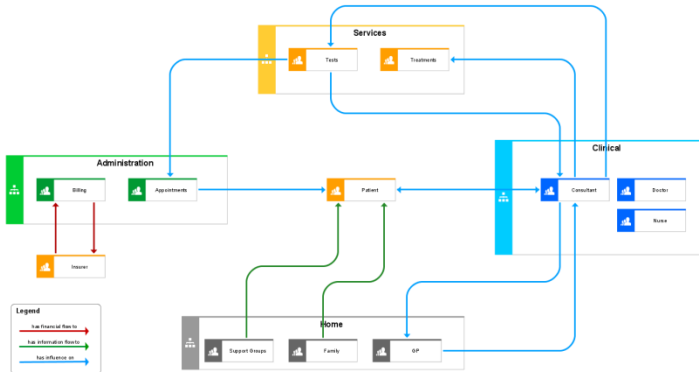

Business Model Canvas

Define your Digital Business Model

Customer Journeys

Discover touchpoints and moments of truths along the customer journeys



ECOSYSTEM MODELING

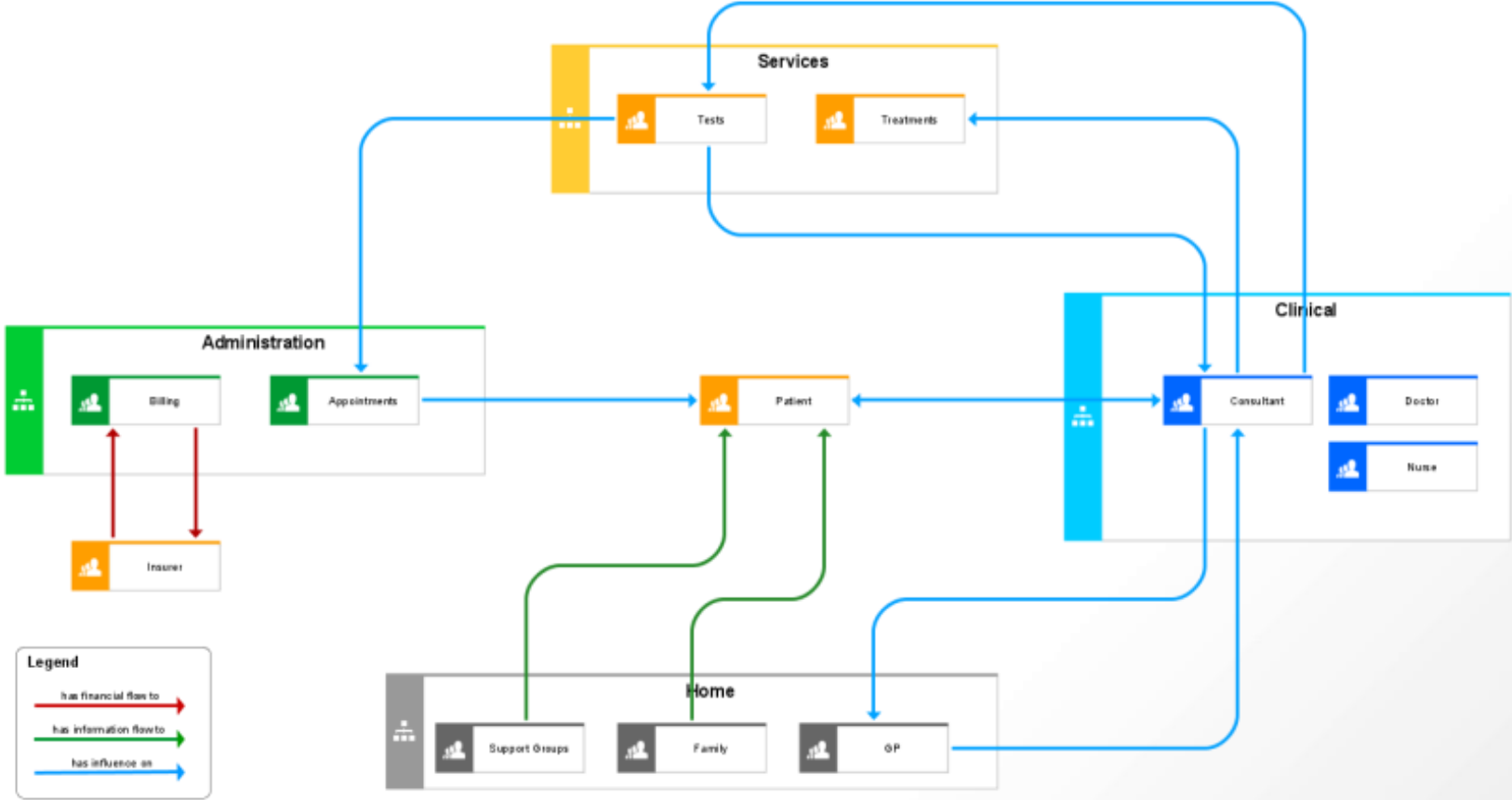

CUSTOMER JOURNEY MAPS

Business from another Perspective

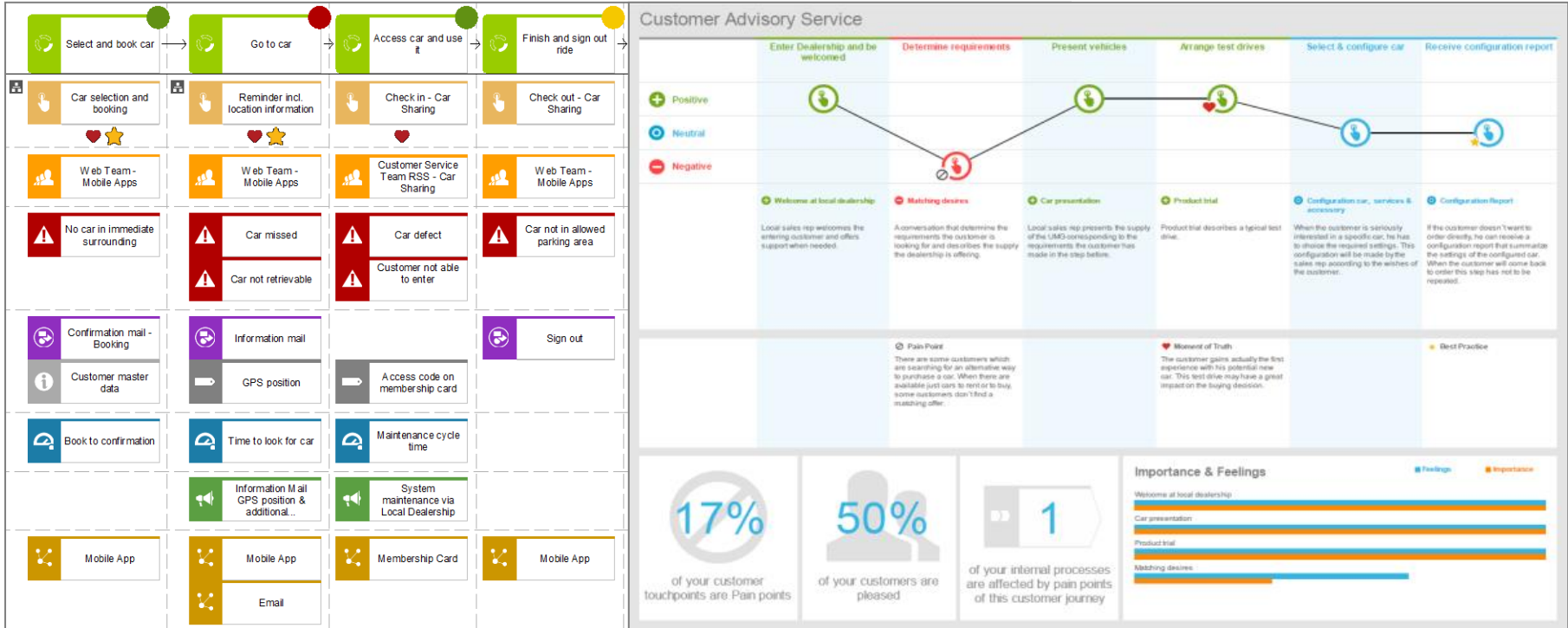

INTEGRATED SEMANTIC CHECKS

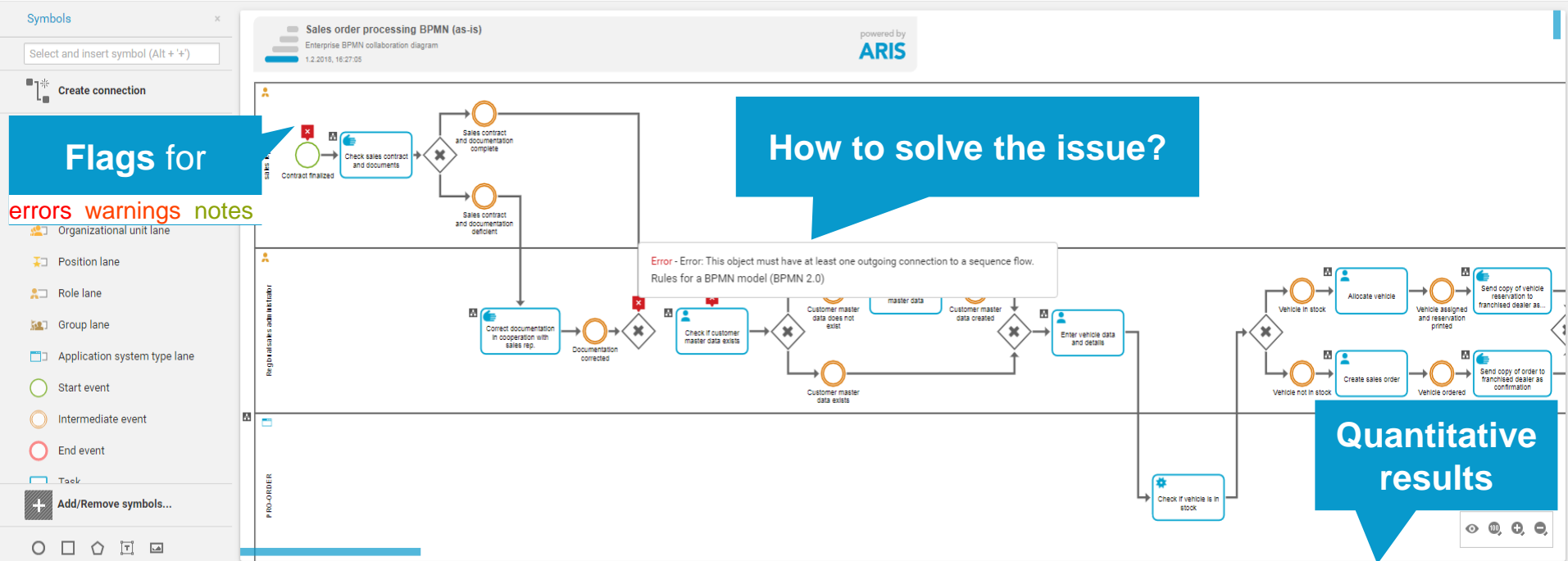

Flags for
errors warnings notes

How to solve the issue?

Quantitative
results

Validation of a BPMN diagram (BPMN 2.0)

4 errors 0 warnings 0 notes

#	Item	Finding	Description
1	● Check if customer master data exists	Rules for a BPMN model (BPMN 2.0)	Error: This object must have at least one incoming connection with a sequence flow.
2	● Contract finalized	Rules for a BPMN model (BPMN 2.0)	Error: This start event violates the following rule: If a process uses objects of type 'Start event', at least one object of type 'End event' is required.
3	● Customer informed		'Customer informed' violates the following rule: If a process uses objects of type 'End event', at least one object of type 'Start event' is required.
4	● Gateway		Error: This gateway violates the following rule: If a process uses objects of type 'XOR gateway', at least one outgoing connection to a sequence flow is required.

Click through step-by-step.
See what is wrong and how to solve the issue.

TRIGGER-BASED REPORTS AND SEMANTIC CHECKS

Improve modeling efficiency, quality and maturity by automating tasks, e.g.

- EXECUTE SEMANTIC CHECK WHEN SAVING
- MAINTAIN IMPORTANT ATTRIBUTES WHEN PLACING OBJECTS / CONNECTIONS OR WHEN SAVING

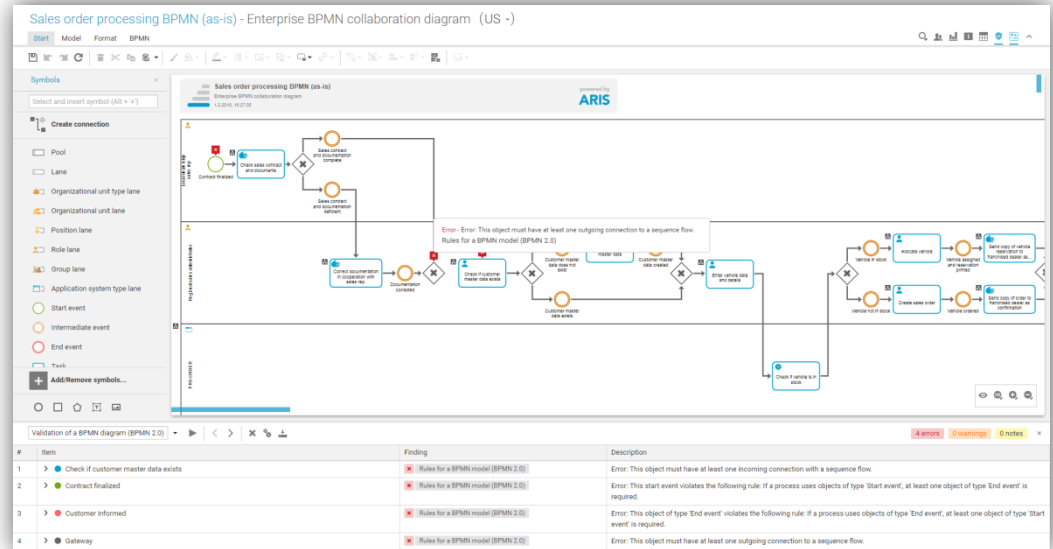
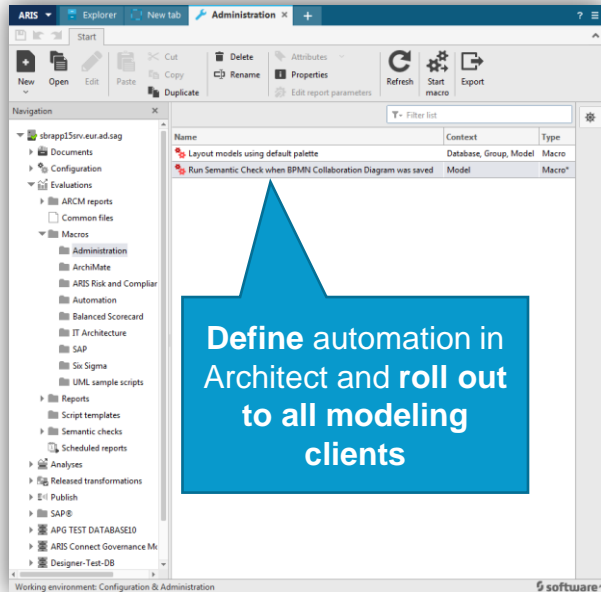

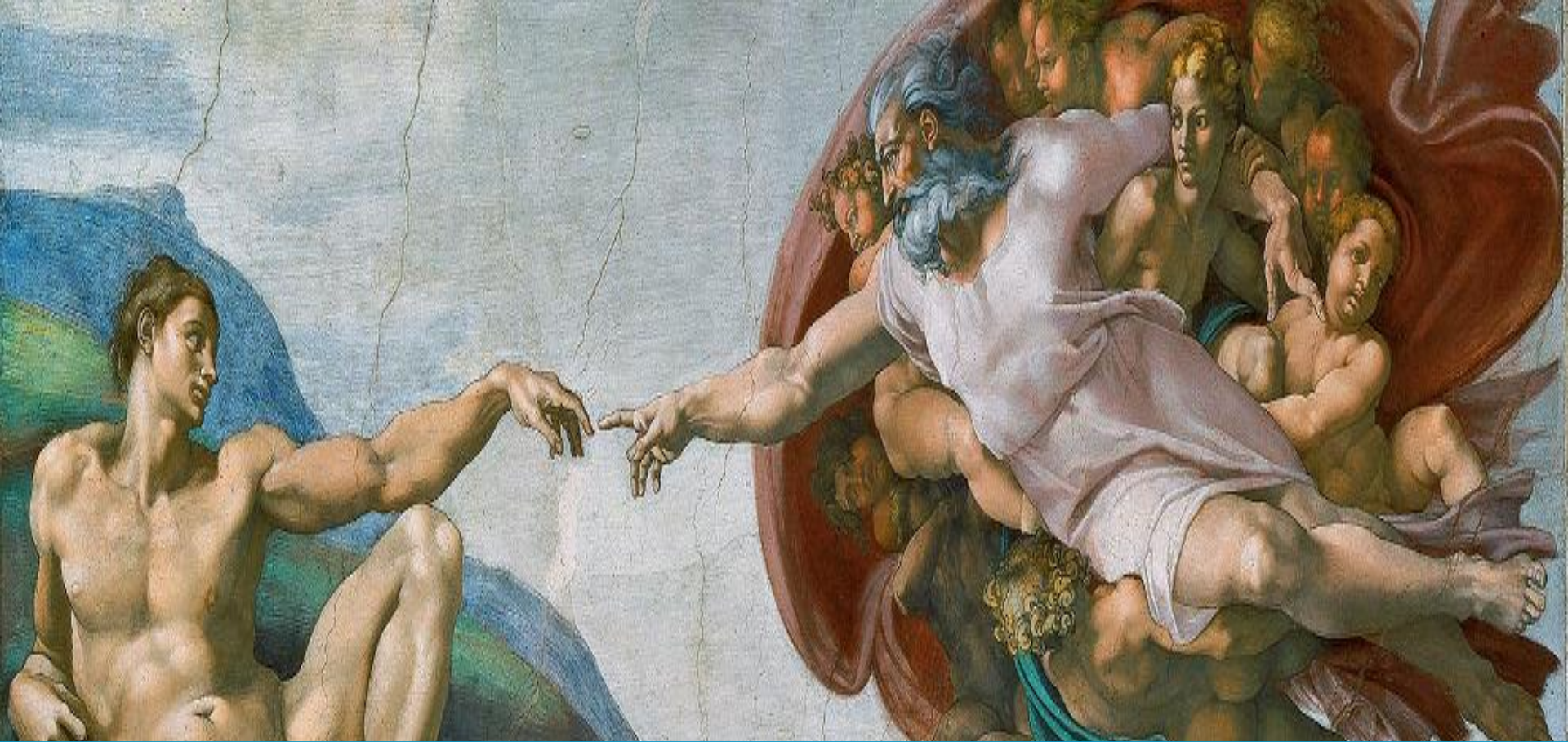

BUSINESS AND IT ALIGNMENT

PROCESSES FOR EXECUTION

AUTOMATIC TRANSFORMATION & ROUNDTIPPING

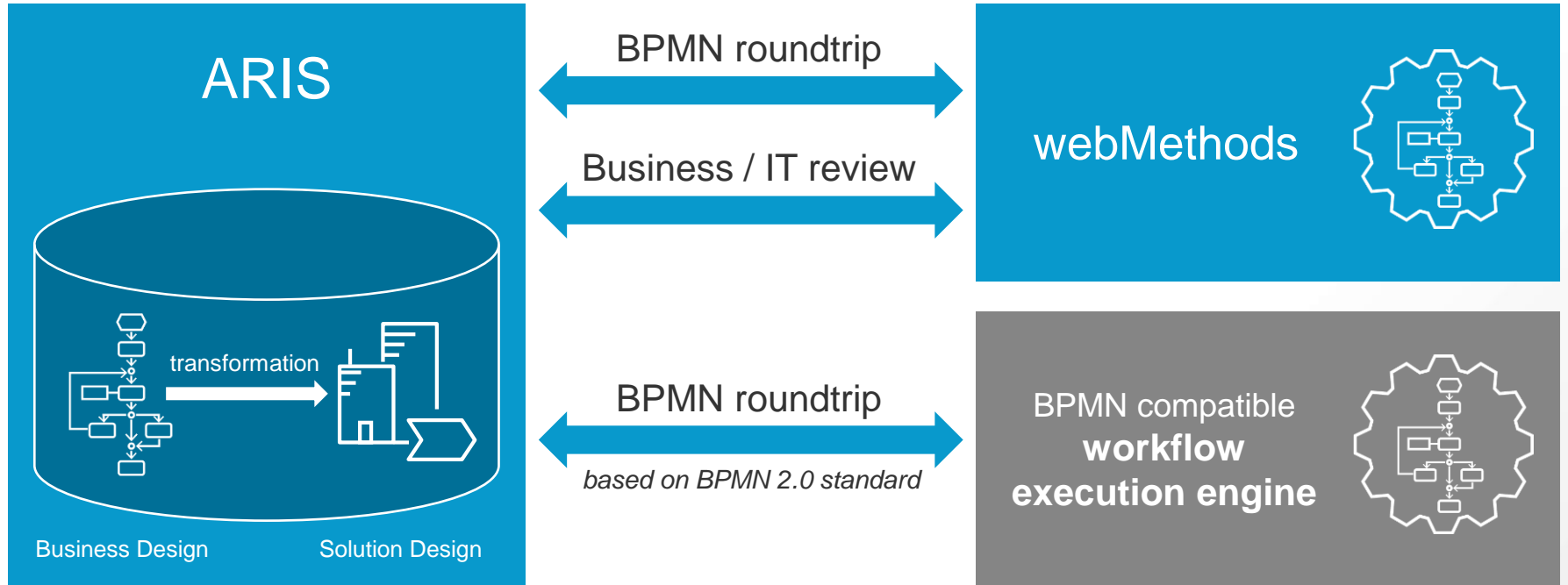



THE OMG CHECKLIST

- ✓ **Design** capabilities: Can all models of a test suite be modeled with a correct result (types, attributes, visualization)?
- ✓ **Export**: Can the designed models be correctly exported (file validity, types, attributes)?
- ✓ **Import**: Can all models of a test suite be imported correctly (visualization, objects, types, attributes)?
- ✓ **Roundtripping**: Can imported models again be exported without any loss of information?



ARIS is one of three tools **with top results (100%)** | **33 tools** evaluated **overall**



Vendor	Tool	BPMN 2.0	Import	Export	Roundtrip	A Results Submitted	B Results Submitted	C Results Submitted	Website
Software AG	ARIS Architect 10.0.2	+	+ Diff	+ Diff	+ Details	+ 24/24	+ 8/8	+ 18/18	🔗

Source: <http://bpmn-miwg.github.io/bpmn-miwg-tools/> (2018-06-20)

BPMN 2.0 IN ARIS

CHEAT SHEET



Top-ranked BPMN 2.0 implementer by OMG
Full BPMN 2.0 Process Modeling Conformance

software AG

MAIN MODEL TYPES

BPMN collaboration & process diagrams represents control flows and message flows involved in collaborative **processes**.

Enterprise BPMN collaboration & process diagrams enrich the standard by typed lanes. Lanes can state roles, organizational units, application systems etc. that are already maintained in the ARIS library.

SWIMLANES

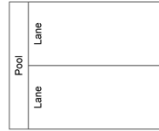

Pools graphically show participants or processes in a collaboration diagram.

Lanes demonstrate organizational and technical responsibilities, typically within pools.

ENTERPRISE BPMN LANES

- Pool
- Lane
- Organizational unit lane
- Organizational unit type lane
- Role lane
- Position lane
- Group lane
- Application system type lane

CONTROL FLOW ELEMENTS

- Event
- Task
- Call activity
- Sub-processes
- Gateway

FURTHER ELEMENTS

- Message
- Text annotation
- Data object
- Data store
- Group

EVENTS

- Start events** demonstrate where a certain process will start.
- Intermediate events** affect the process flow. They do not start or end the process.
- End events** demonstrate where a certain process will end.

Events are further specified as follows:

- Cancel event
- Compensation event
- Condition event
- Error event
- Escalation event
- Link event
- Message event
- Multiple event
- Parallel multiple event
- Signal event
- Timer event

EXAMPLE Applicant selection

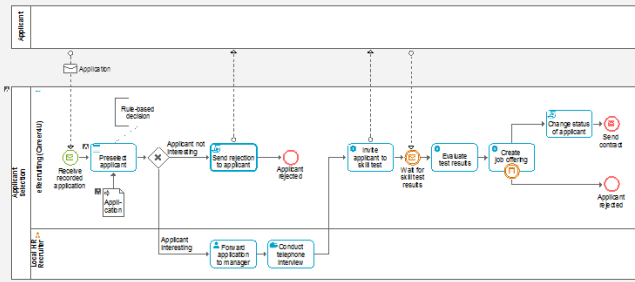

ACTIVITIES

- Activities are included as steps in a process.
- Call activities demonstrate points in the process where global processes or tasks are used.

Tasks are further specified as follows:

- Business rule task
- Manual task
- Receive task
- Script task
- Send task
- Service task
- User task

FLOWS

- Sequence flows** represent the order of activities that are performed within a process.
- Message flows** show the flow of messages between pools.
- Associations** link information with elements.

GATEWAYS

- Gateways** are used in processes to control the disparity and convergence of sequence flows.
- Exclusive gateways** are decisions that represent alternative paths in a process.
- Parallel gateways** combine and create parallel flows.
- Inclusive gateways** represent alternative but also parallel paths in a process flow. Difference to exclusive gateways: All condition expressions are evaluated.
- Complex gateways** demonstrate complex synchronization behavior, conditions and situations.
- Event-based gateways** are used as branching points within the process. Alternative paths are based on occurring events.

SUB-PROCESSES

- Sub-processes** represent activities which include activities, gateways, events and sequence flows.
- Ad hoc sub-processes** represent activities with no sequence relationships.
- Event sub-processes** operate event-handling within a process and are typically related to exceptions.
- Transaction sub-processes** demonstrate coordinated activities such as a business transaction, a rollback or a compensation.

DATA

- Data objects** provide information about what activities require to be performed or what they produce.
- Data stores** demonstrate stored information that will last beyond the process.
- Messages** show communication contents between participants.

ARIS AS AN OMG CHAMPION

DECISION MODELING NOTATION (DMN)



	Input				Output		Annotation
U	Guests count	With Children	Season	Weather Conditions	Table Number	Terrace	Annotation 1
	1...4, 2, >4	Yes, No	Spring, Summer, Wint...	sunny, rainy, windy, col...	1,2,3,4,5,6,7,8,9,10,11,...	Yes, No	
1	1...4	Yes	Winter	sunny	1	Yes	
2	>4	No	Summer	sunny	5, 6, 7	Yes	
3	2	No	Summer	rainy	6		please deposit blankets
4	>4	Yes	Spring	rainy	2, 3		
5	1...4	No	Fall	sunny	4, 8, 9		
+	Create new rule						

- 1 DMN 1.2 Decision Modeling
- 2 DMN import & export
- 3 Decision tasks in BPMN



Easy & structured decision modeling
Professional process automation

ARIS FOR SAP® SOLUTIONS

INTEGRATION WITH SAP SOLUTION MANAGER 7.2

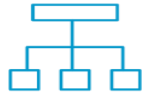

SAP® Process Design and Blueprinting



Testing of SAP® Solutions



Training and Go-Live of SAP® Solutions



Communication of SAP® Solutions

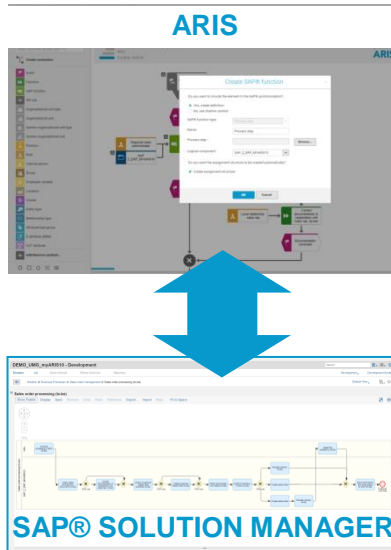

- 1 Exchange BPMN process diagrams
- 2 Synchronization of Executable Library and scoped branches
- 3 Wizard-based support (in ARIS Connect Designer) for
 - modeling SAP functions
 - creating SAP-related documents and SAP executables (such as transactions and Fiori apps)
- 4 Integration with SAP Enable Now

PROCESS-DRIVEN MIGRATION TO SAP® S/4HANA

ARIS IS WELL-ALIGNED WITH SAP ACTIVATE



ARIS GUARANTEES

1. Transparency and understanding of status quo (processes, system)
2. The cornerstone of a successful migration to S/4HANA
3. Efficient SAP testing, training and operation



ARIS FOR SAP® SOLUTIONS

INTEGRATION WITH SAP ENABLE NOW

Asset from SAP Enable Now connected to ARIS objects and models



Import Process Structures



Import Links to Training Assets



Navigate to ARIS Model in ARIS Connect during asset creation

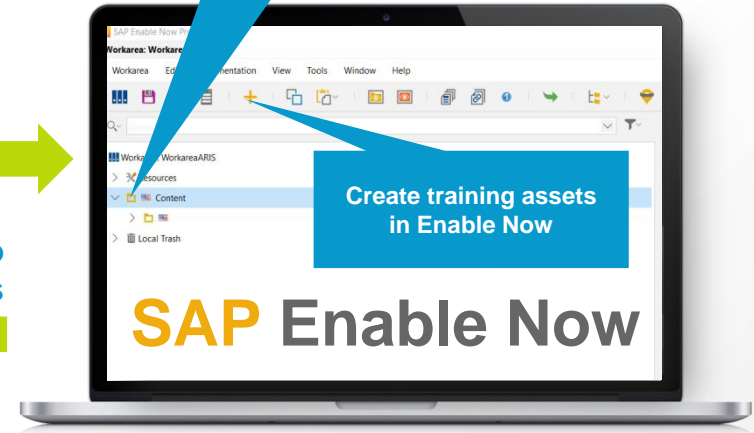

Create training assets in Enable Now

Creating of SAP training materials based on ARIS process models

A large, dense crowd of people is shown from a high angle, filling the entire frame. The crowd is diverse in age and appearance, with many individuals wearing sunglasses and casual summer attire. A horizontal blue banner with a subtle pattern is overlaid across the middle of the image, containing the text "USER EXPERIENCE IS KEY" in white and yellow. The text is centered and occupies a significant portion of the banner's width. The overall scene suggests a large-scale outdoor event or festival.

USER EXPERIENCE IS **KEY**

SMART MODELING EXCELLENT VISUAL QUALITY WITH EASE

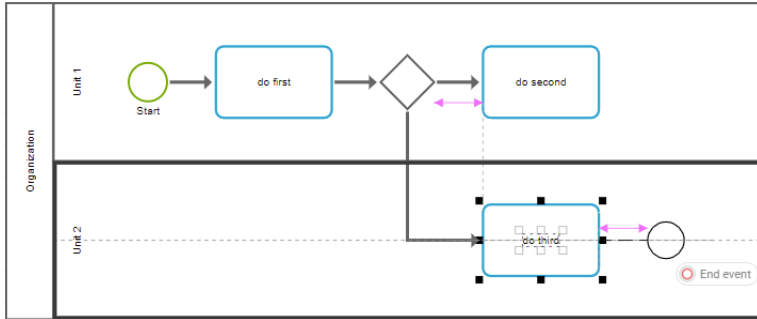

Guided alignment

➔ Significantly reduced layouting effort

New object panel

Copy / paste from repository to Connect Designer

Improved click and place

Use of attribute groups for faster selection

Jump from ARIS Connect Designer to Portal View

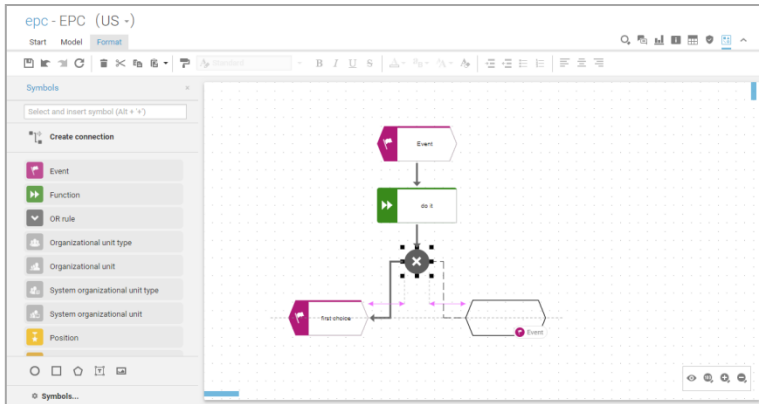

SINGLE-SOURCE-OF-TRUTH FOR EVERYONE WITH EMBEDDED VIEWS

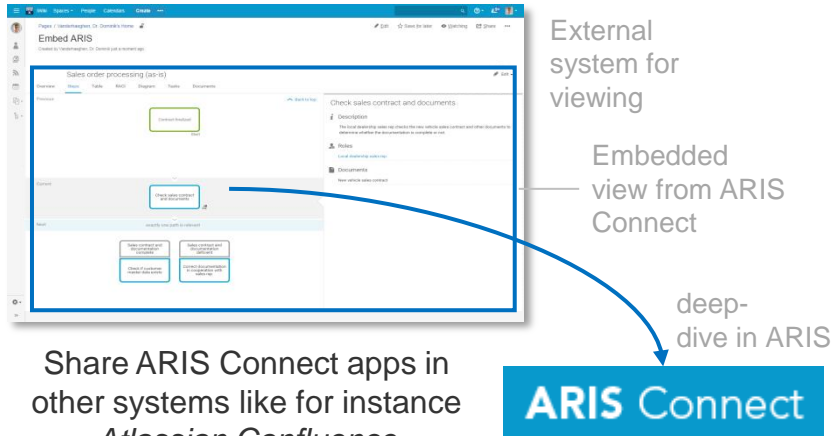

Share ARIS Connect apps in other systems like for instance *Atlassian Confluence*

1 **Embed ARIS Connect** within external applications (e.g. Atlassian Confluence) to reach the daily work environment of business users; publish the

- Diagram
- Steps view
- Overview fact sheet

within the 3rd party portal as simple as embedding a video player from popular video platforms like YouTube.

Easy spread of business knowledge

PERSONALIZED NAVIGATION AND VIEWING

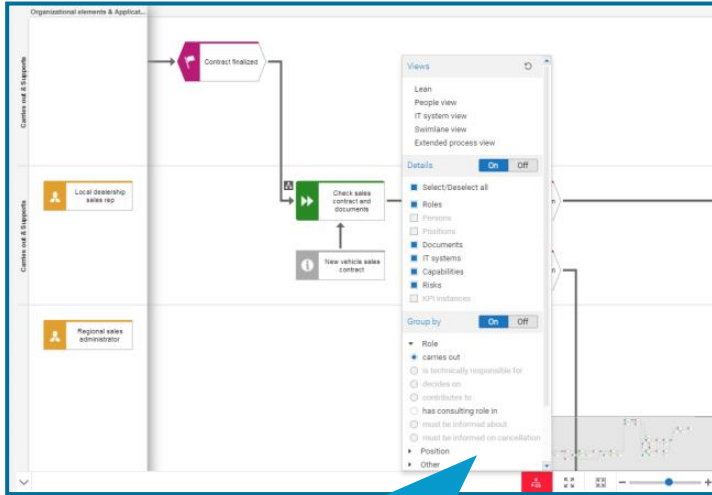

View generation 2.0 –
Focus on the right
details (e.g. E2E
process)

Highlighting your details

Your tasks; happy path of a process



Thumbnail view, Search in diagram, Navigation

Easy & fast viewing / search

< > ↑ Sales order processing (as-is) ★

Overview Steps Table RACI **Diagram** Documents

Sales order processing (as-is)

EPC
Aug 24, 2018 10:12:54 AM

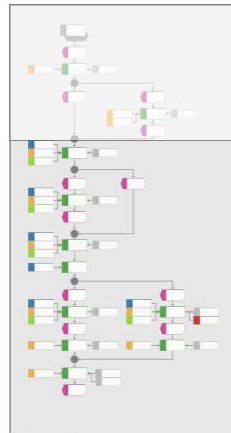
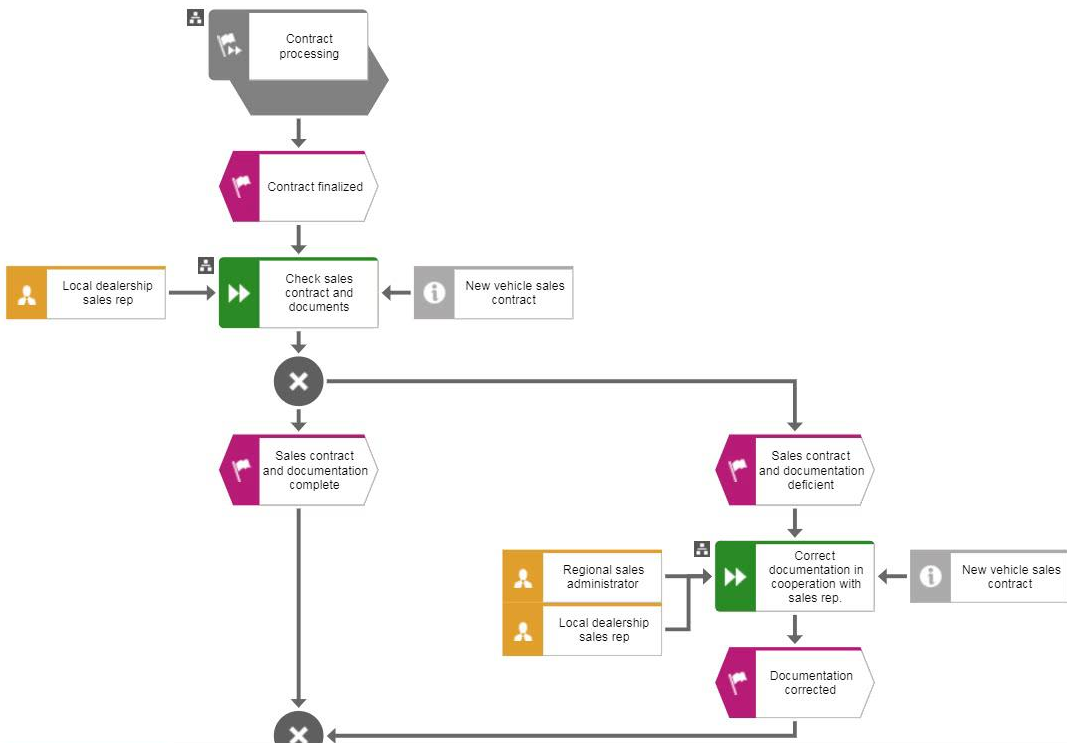

Highlighting On Off

Basic highlighting

- Process paths
- Roles
- General documents
- IT systems

Basic highlighting

- Process paths
- Roles
- General documents
- IT systems

Management details

- Status (CMA)
- Cost rate

Details on all IT Systems

- Manufacturer
- Number of internal users
- Criticality
- System type

MOBILE WORK INSTRUCTIONS

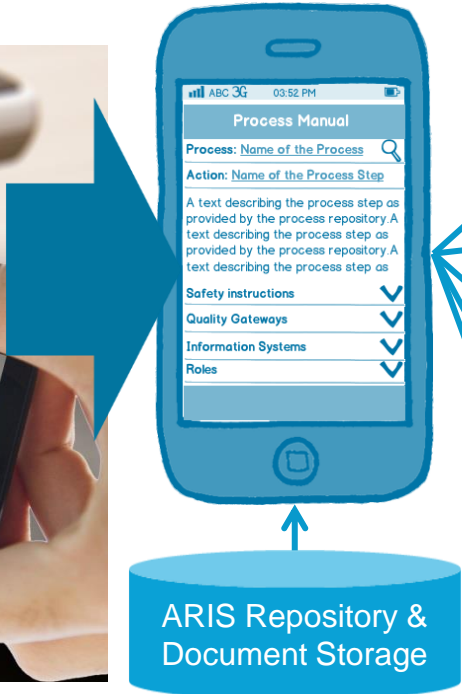

How-to videos



Working instructions



Safety policies



Roles involved



IT-System information

SPEECH-BASED INTERACTION WITH ARIS

ARIS FOR ALEXA® DEMO AVAILABLE THE SKILLS STORE

1

Alexa, ask ARIS: *Who is the Head of Procurement?*

2

Alexa, ask ARIS: *Show me the processes, Controlling is involved in.*

3

Alexa, ask ARIS: *Which process step has the longest throughput time?*

Gartner forecasts a **growth of speech-based virtual personal assistances of nearly 600%** by 2020 (from 2015)

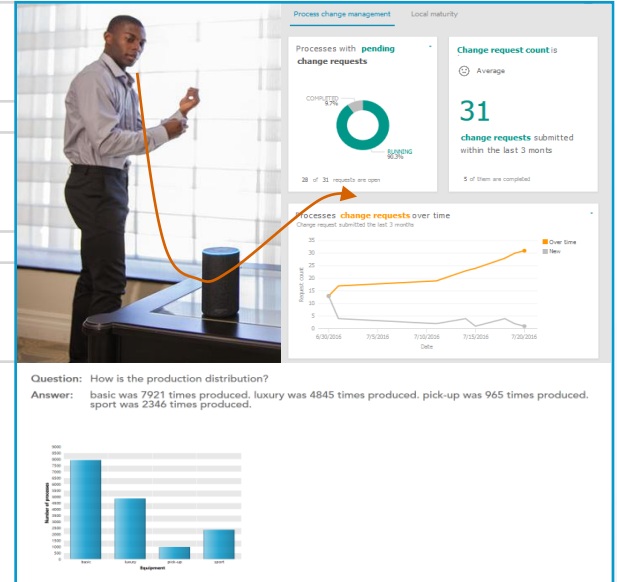

APPLE SUPPORT PROCESS MODELING ON MACOS WITH SAFARI



Apple support for
Connect Viewer &
Connect Designer

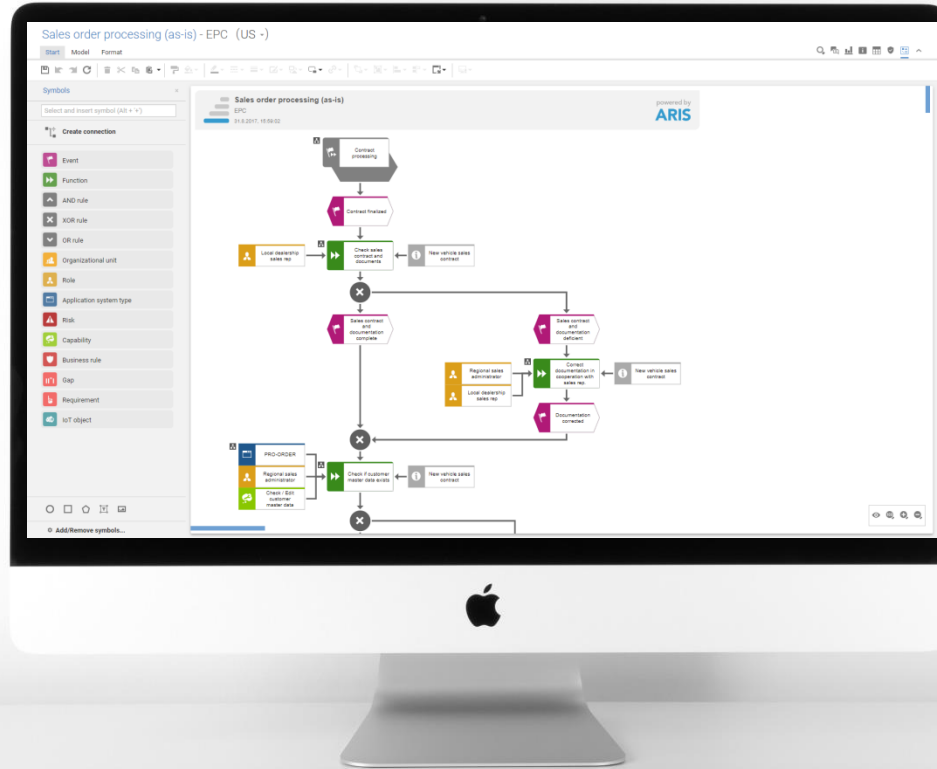

MacOS 10
&
Safari 11+

DATA PROTECTION and COMPLIANCE



ARIS GOVERNANCE, RISK & COMPLIANCE



Risk Management

Risk Manager

Incident & Loss Management
Risk & Process Simulation



Compliance Management

Compliance Officer

Issue Management
Sign off Mngt
Regulatory Change Management
Stress Testing



Policy Management

Policy Manager

Policy Mapping & Tracking
Attestation



Audit Management

Auditor

Audit Planning
Audit Templates
Resource Management

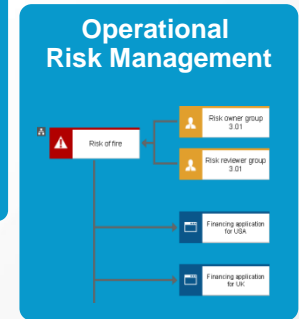
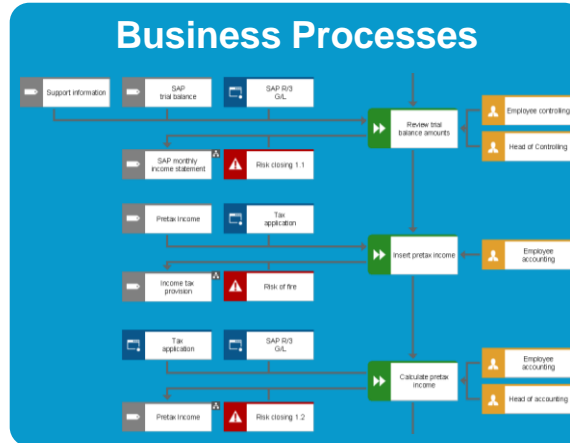
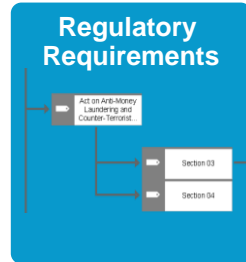
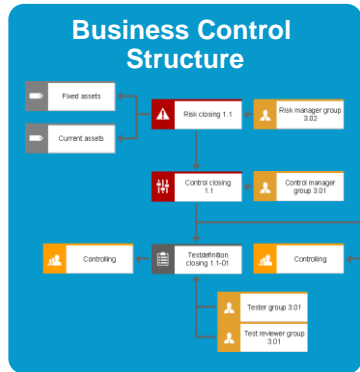

YOUR WAY TO GDPR COMPLIANCE

PREPARE
your organization



EVALUATE
processing activities



IMPROVE
your organization



ENSURE
compliance



Monitor project status and results

Processing Activities related to the unit
Number of activities related to the current unit

7

New Processing Activities related to t...
Number of new activities in the given time per...

+1

Period in days

Processing activities with new incidents
Number of processing activities with incidents...

0

Period in days

Total Incidents for the unit
Total number of incident for activities in the u...

4

New Processing Activities over Time

Number of processing activities related to the current unit

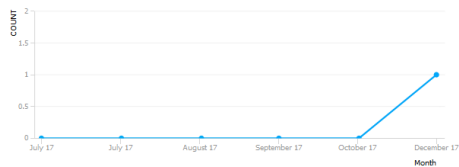

New Incidents over Time

Number of new occurring incidents over time (last 6 Months)

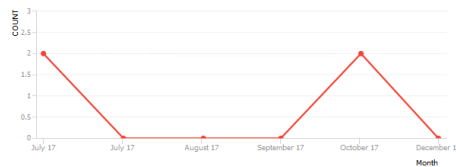

Extended GDPR Management Report

2017-09-13

UMG Bank IT & Orga
Organizational Unit

Processing Activity Description

Sales order processing (as-is)

Key Data

Description

Sales order processing follows the contract processing after finalizing a contract. Within this process, the sales contract and documents are checked again as well as the customer master data. After this the regional sales administrator triggers the vehicle provisioning and places an order if it is not in stock. The process ends by informing the customer about the status of his order and with a confirmation from the local sales dealership in charge.

Processing Activity Data

Time of generation	Jun 23, 2017 11:19:18 AM
Creator	Peter Green
Last Change	Jun 23, 2017 11:19:18 AM
Last User	Vittorio De Angelo

10 | Sales Order Processing (as-is)
Description

ARIS
BY SOFTWARE AG

THE WAY TO GDPR COMPLIANCE

PREPARE your organization

Run **readiness survey**

Set up data, IT & process
inventories

Build **Records of Processing
Activities (ROPA)**

Enrich Processing Activities
(PA) information

Separate PAD
questionnaire templates
for **controller** and
processor

EVALUATE processing activities

Qualify PAs for Data
Protection Impact Assessment
(DPIA)

Assess PA risks

Run DPIA for high-risk PAs

Evaluate need for
improvement measures

Questionnaire template
for **DPIA**
DPIA Dashboard
DPIA Report

IMPROVE your organization

Mitigate GDPR risk

Implement or adapt processes
& systems

**Establish GDPR compliance
policies** in the organization

Implement incident
management **system**

ENSURE compliance

Test internal controls & risk
mitigation measures

Sign off business organization
hierarchies

Plan & execute internal **GDPR
audits**

GDPR COMPLIANCE WITH ARIS



- 1 Questionnaire template for **Data protection Impact Assessment (DPIA)**
- 2 **DPIA Report**
- 3 **DPIA Dashboard**
- 4 **Separate PAD questionnaire templates for controller and processor**

Compliance Manager
Data Protection Manager

MAKE DATA PROTECTION PRACTICES A HABIT

Turn data privacy protection into a competitive advantage

- Establish data policies
- Evaluate the implications for your industry
- Build a record of processing activities
- Perform data protection impact assessments
- Implement risk mitigation measures
- Establish incident management
- Ensure compliance

[GDPR.SOFTWAREAG.COM](https://www.gdpr.softwareag.com)

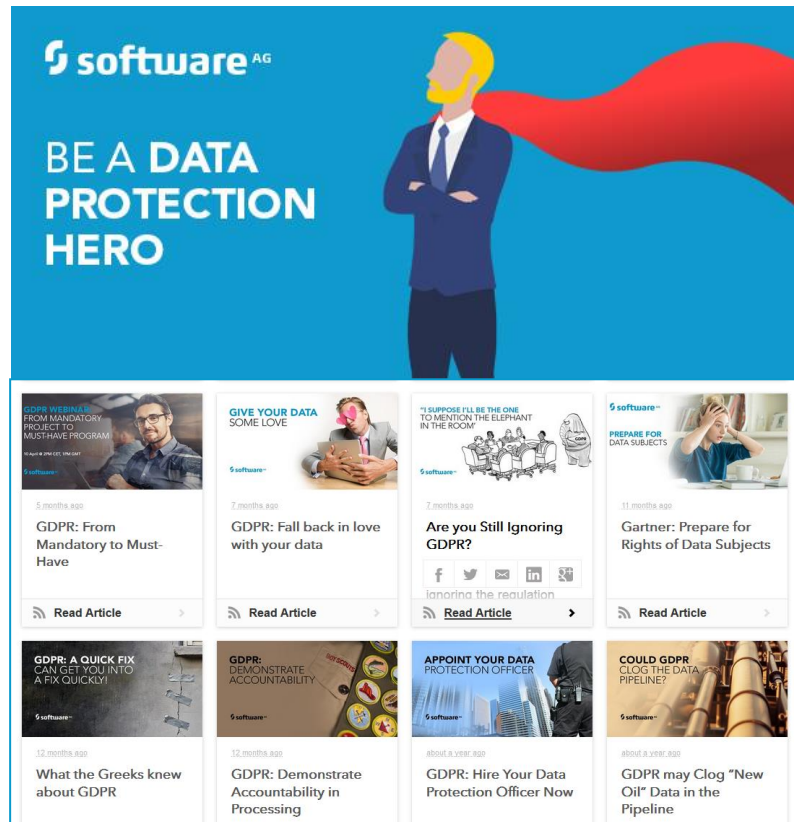

The image shows a promotional banner for Software AG and a grid of eight article thumbnails. The banner at the top features the Software AG logo and the text "BE A DATA PROTECTION HERO" next to an illustration of a man in a suit with a red cape. Below the banner is a grid of eight article thumbnails, each with a title, a small image, and a "Read Article" button.

Article Title	Thumbnail Description
GDPR: From Mandatory to Must-Have	Man in a blue shirt looking at a laptop.
GDPR: Fall back in love with your data	Man in a suit holding a laptop with a pink heart on his forehead.
Are you Still Ignoring GDPR?	Illustration of people sitting at a table with a speech bubble.
Gartner: Prepare for Rights of Data Subjects	Man in a blue shirt looking at a laptop.
GDPR: A QUICK FIX CAN GET YOU INTO A FIX QUICKLY!	Illustration of a person sitting at a desk with a computer.
GDPR: Demonstrate Accountability in Processing	Illustration of a person sitting at a desk with a computer.
GDPR: Hire Your Data Protection Officer Now	Illustration of a person in a dark uniform standing in front of a city skyline.
GDPR may Clog "New Oil" Data in the Pipeline	Illustration of a person in a dark uniform standing in front of a city skyline.

MANAGEMENT HEATMAP

BEST PRACTICE VISUALIZATIONS FOR RELIABLE DECISIONS

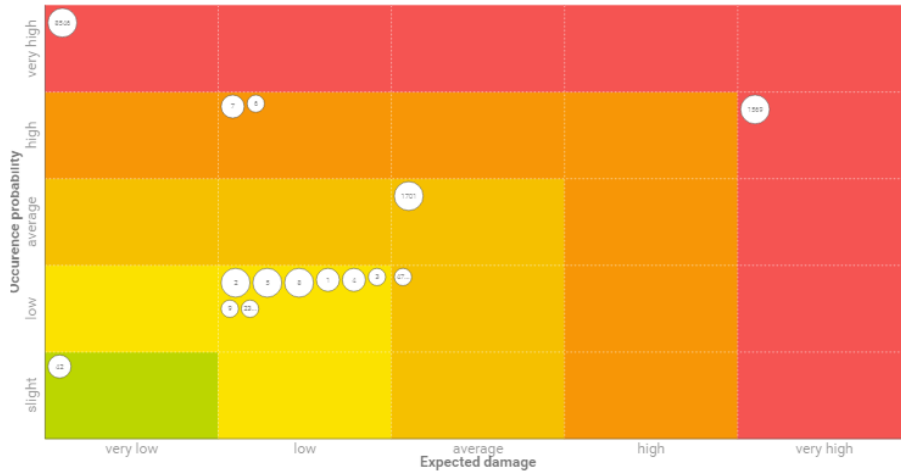

- 1 **Visualize risks** in three dimensions
- 2 Define your **individual** scales, colors & risk categories
- 3 Derive **actions** for critical risks – jump to ARCM and proceed
- 4 Filter for specific risk categories and get the details

NEW USE CASES FOR ARIS AWARE

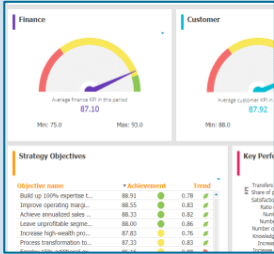

Strategy

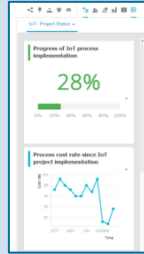

Internet of Things

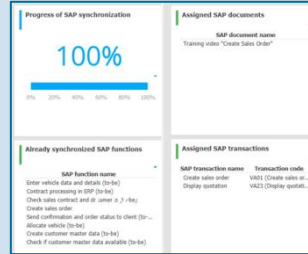

SAP Synchronization

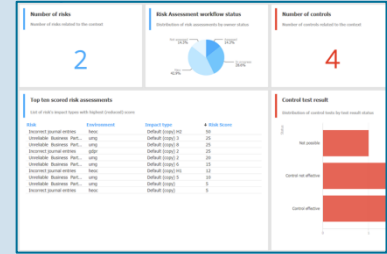

Risk & Compliance



Center of Excellence

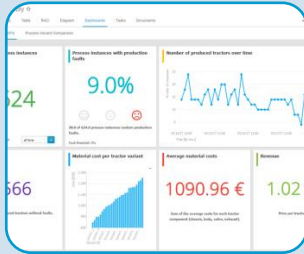

Process Performance

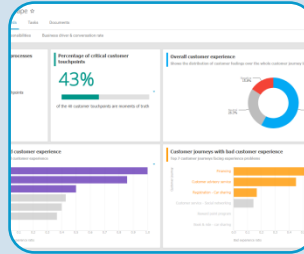

Customer Experience



Enterprise Architecture

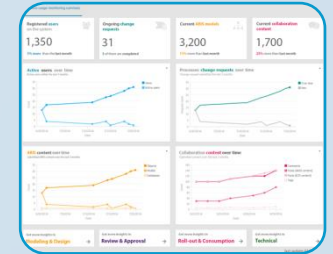

Business Usage

ARIS IS AVAILABLE IN THE CLOUD



ARIS Cloud Trial Public cloud

- Start your first process improvement project immediately
- Use basic modeling, analysis, admin & standard sharing



30-day free trial!



ARIS Cloud Advanced Public cloud

- You already have experience in process modeling
- Advanced modeling with own filters, analysis, sharing, administration
- Manage cross-departmental projects

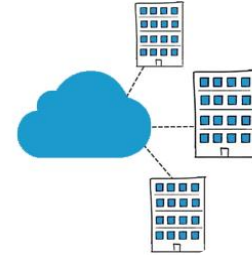

ARIS Cloud Enterprise Private cloud

- Establish a digital transformation journey
- Enjoy complete ARIS capabilities covering expert modeling & analysis, customized sharing, full administration
- Incl. SAP, IoT, EA and GRC

software AG



helge.hess@softwareag.com



+49 681 210 3876
+49 172 6868 755